

Ficha Técnica



CODIGO	POTÊNCIA	LM	TENSÃO
9620001212CW	200w	27000lm	85-265v

ESPECIFICACIONES TÉCNICAS

Ângulo de abertura	-	120°
Temperatura de cor	-	5700k
IRC	-	>80
LED Chip	-	LUXEON 3030 2d
Temperatura de trabalho	-	-20°/50°
Material	-	Aluminio
Dimensões	-	350x182mm
Certificados	-	CE&Rohs

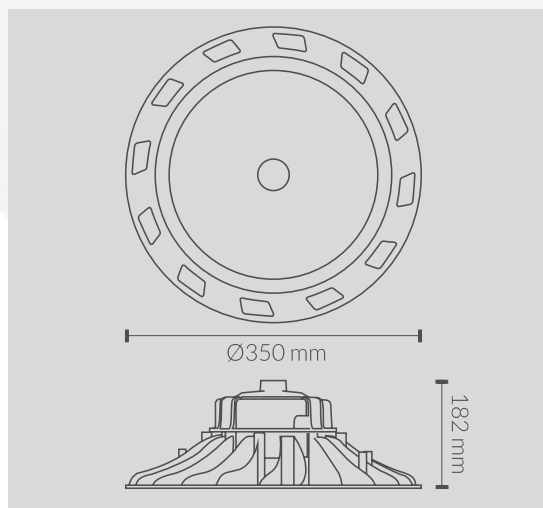

PROTECCIONES DEL DRIVER

PROTEÇÕES DO DRIVER

OVP	Protección contra sobretensión <i>Proteção contra sobretensão</i>
SCP	Protección contra cortocircuitos <i>Proteção contra curto-circuito</i>
OPP	Protección de sobrecarga <i>Proteção de sobrecarga</i>
OTP	Protección contra sobrecalentamiento <i>Proteção contra superaquecimento</i>